

# GP1A50HR/GP1A51HR GP1A52HR/GP1A53HR

## OPIC Photointerrupter

### ■ Features

1. High sensing accuracy (Slit width : 0.5mm)
2. LSTTL and TTL compatible output
3. Both-sides mounting type : **GP1A50HR** (Gap: 3mm)  
 Either-side mounting type : **GP1A51HR** (Gap: 3mm)  
 PWB mounting type : **GP1A52HR** (Gap: 3mm)  
**GP1A53HR** (Gap: 5mm)

### ■ Applications

1. OA equipment, such as printers, facsimiles, etc.
2. VCRs

\*\*OPIC\*\* (Optical IC) is a trademark of the SHARP Corporation.  
 An OPIC consists of a light-detecting element and signal-processing circuit integrated onto a single chip.

### ■ Outline Dimensions

(Unit : mm)

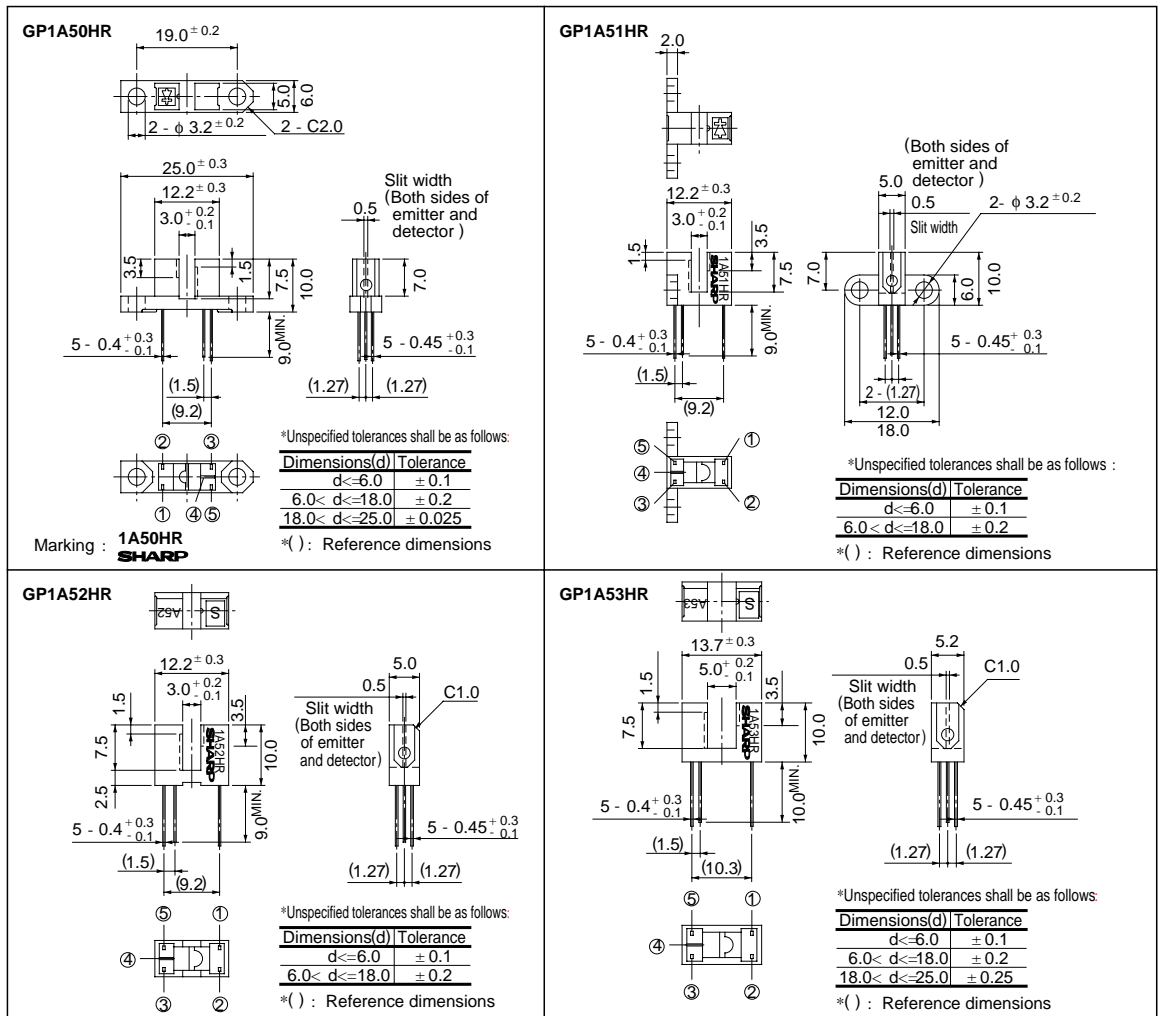

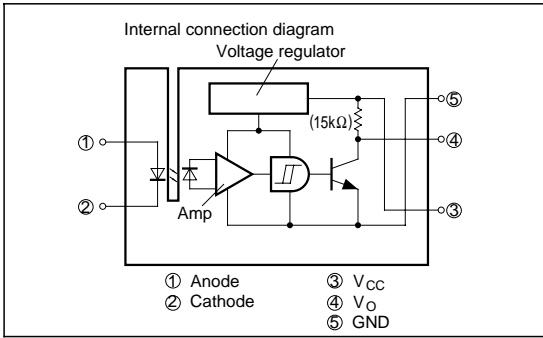

## Absolute Maximum Ratings

(T<sub>a</sub> = 25°C)

	Parameter	Symbol	Rating	Unit
Input	Forward current	I <sub>F</sub>	50	mA
	*1 Peak forward current	I <sub>FM</sub>	1	A
	Reverse voltage	V <sub>R</sub>	6	V
	Power dissipation	P	75	mW
Output	Supply voltage	V <sub>CC</sub>	- 0.5 to + 17	V
	Output current	I <sub>O</sub>	50	mA
	Power dissipation	P <sub>O</sub>	250	mW
Operating temperature		T <sub>opr</sub>	- 25 to + 85	°C
Storage temperature		T <sub>stg</sub>	- 40 to + 100	°C
*2 Soldering temperature		T <sub>sol</sub>	260	°C

\*1 Pulse width ≤ 100 μs, Duty ratio = 0.01

\*2 For 5 seconds

## Electro-optical Characteristics

(T<sub>a</sub> = 25°C)

Parameter		Symbol	Conditions	MIN.	TYP.	MAX.	Unit	
Input	Forward voltage	GP1A50HR/GP1A51HR GP1A52HR	V <sub>F</sub> I <sub>F</sub> = 5mA	-	1.1	1.4	V	
		GP1A53HR	V <sub>F</sub> I <sub>F</sub> = 8mA	-	1.14	1.4	V	
	Reverse current	I <sub>R</sub>	V <sub>R</sub> = 3V	-	-	10.0	μA	
Operating supply voltage		V <sub>CC</sub>		4.5	-	17.0	V	
Output	Low level output voltage	V <sub>OL</sub>	V <sub>CC</sub> = 5V, I <sub>F</sub> = 0, I <sub>OL</sub> = 16mA	-	0.15	0.4	V	
	High level output voltage	V <sub>OH</sub>	V <sub>CC</sub> = 5V, *5 I <sub>F</sub> = 5mA	4.9	-	-	V	
	Low level supply current	I <sub>CCL</sub>	V <sub>CC</sub> = 5V, I <sub>F</sub> = 0	-	1.7	3.8	mA	
	High level supply current	I <sub>CCH</sub>	V <sub>CC</sub> = 5V, *5 I <sub>F</sub> = 5mA	-	0.7	2.2	mA	
Transfer characteristics	*3 "Low→High" threshold input current	GP1A50HR/GP1A51HR GP1A52HR	I <sub>FLH</sub> V <sub>CC</sub> = 5V	-	1.0	5.0	mA	
		GP1A53HR	I <sub>FLH</sub> V <sub>CC</sub> = 5V	-	1.5	8.0	mA	
	*4 Hysteresis		I <sub>FHL</sub> / I <sub>FLH</sub>	V <sub>CC</sub> = 5V	0.55	0.75	0.95	
	Response time	"Low→High" propagation delay time	t <sub>PLH</sub>	V <sub>CC</sub> = 5V, *5 I <sub>F</sub> = 5mA R <sub>L</sub> = 280Ω	-	3.0	9.0	μs
		"High→Low" propagation delay time	t <sub>PHL</sub>		-	5.0	15.0	
		Rise time	t <sub>r</sub>		-	0.1	0.5	
Fall time		t <sub>f</sub>	-		0.05	0.5		

\*3 I<sub>FLH</sub> represents forward current when output changes from low to high.\*4 I<sub>FHL</sub> represents forward current when output changes from high to low. Hysteresis stands for I<sub>FHL</sub> / I<sub>FLH</sub>.\*5 GP1A53HR Condition of V<sub>OH</sub>, I<sub>CCH</sub>, Response time; I<sub>F</sub> = 8mA

**■ Recommended Operating Conditions**

Parameter	Symbol	Operating temp.	MIN.	MAX.	Unit
Low level output current	$I_{OL}$	$T_a = 0 \text{ to } +70^\circ\text{C}$	-	16.0	mA
Forward current	$I_F$		10.0	20.0	mA

**Fig. 1 Forward Current vs. Ambient Temperature**

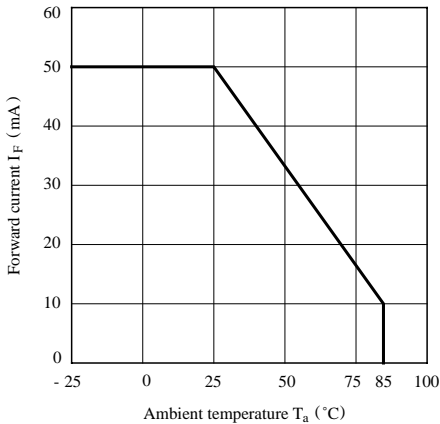

**Fig. 2 Output Power Dissipation vs. Ambient Temperature**

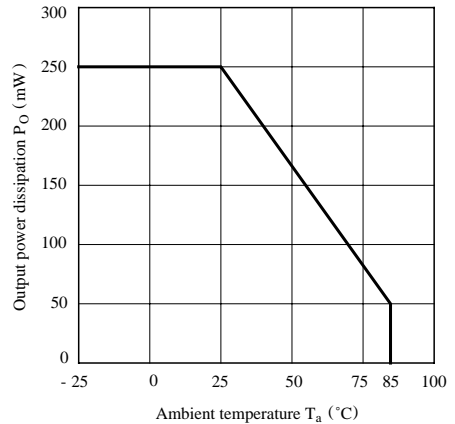

**Fig. 3 Low Level Output Current vs. Ambient Temperature**

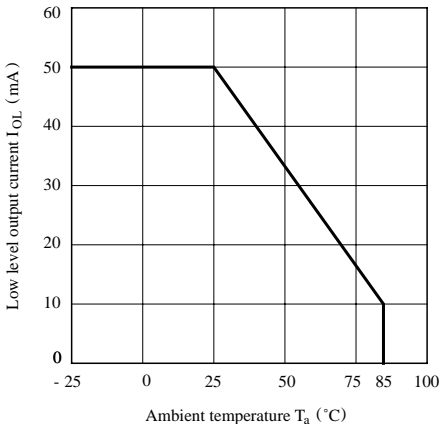

**Fig. 4 Forward Current vs. Forward Voltage**

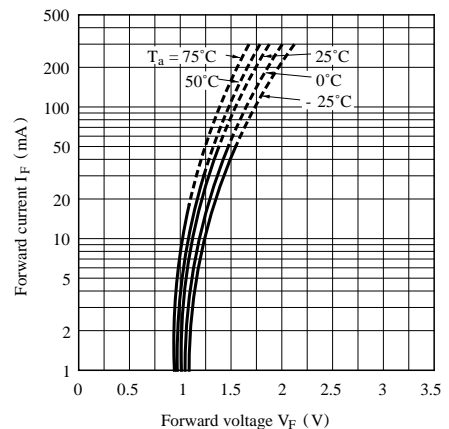

**Fig. 5 Relative Threshold Input Current vs. Supply Voltage**

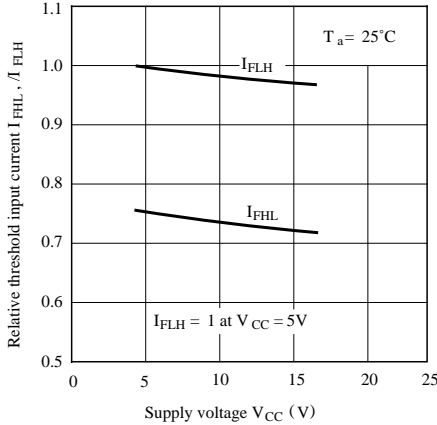

**Fig. 6 Relative Threshold Input Current vs. Ambient Temperature**

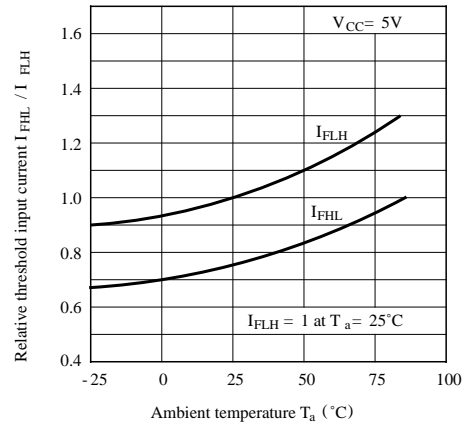

**Fig. 7 Low Level Output Voltage vs. Low Level Output Current**

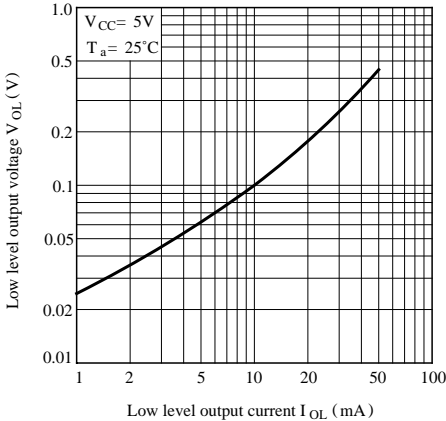

**Fig. 8 Low Level Output Voltage vs. Ambient Temperature**

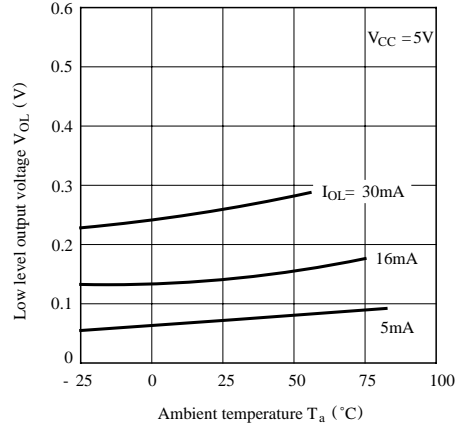

**Fig. 9 Supply Current vs. Ambient Temperature**

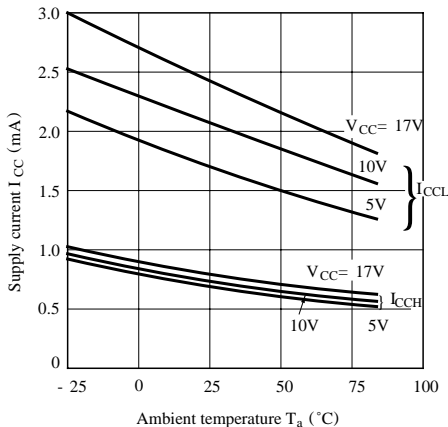

**Fig.10-a Propagation Delay Time vs. Forward Current (GP1A50HR/GP1A51HR/GP1A52HR)**

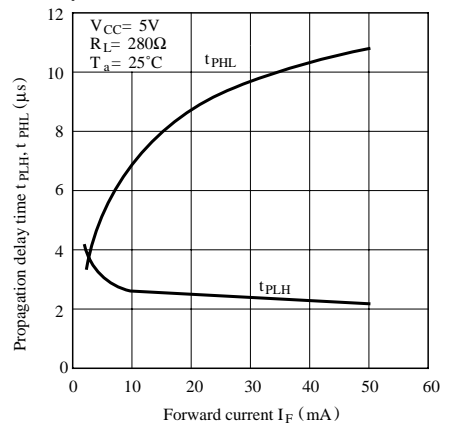

**Fig.10-b Propagation Delay Time vs. Forward Current (GP1A53HR)**

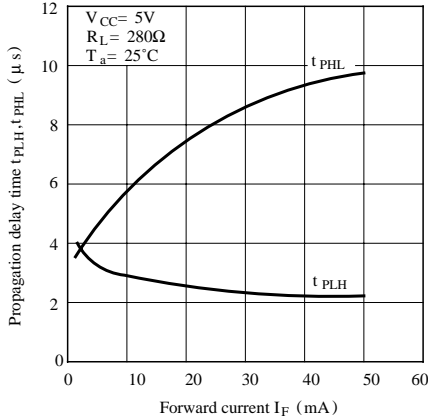

**Fig.12 Rise Time, Fall Time vs. Load Resistance**

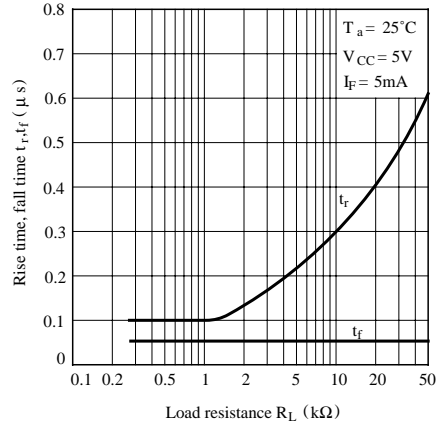

### Test Circuit for Response Time

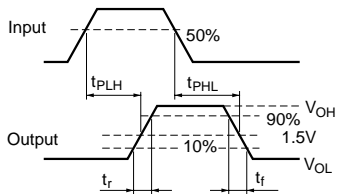
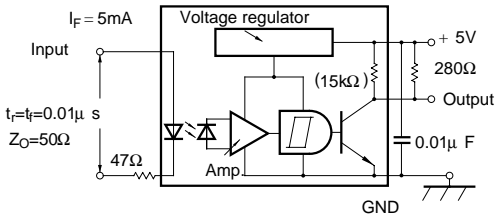

### ■ Precautions for Use

- (1) In order to stabilize power supply line, connect a by-pass capacitor of more than  $0.01\mu F$  between  $V_{CC}$  and GND near the device.
- (2) In case of cleaning, use only the following type of cleaning solvent.  
Ethyl alcohol, Methyl alcohol, Isopropyl alcohol
- (3) As for other general cautions refer to the chapter "Precautions for Use".