

DMG48270F043_02WTC

DMG48270F043_02WTCZ01

DMG48270F043_02WTCZ02

Features:

- Based on T5L0, running DGUS II system.
- 4.3 inch, 480*272 pixels resolution, 262K colors, IPS-TFT-LCD, wide viewing angle.
- LCD and touch panel optical bonding process.
- Optional touch panel appearance of black, white and integrated black.
- COF structure. The entire core circuit of the smart screen is fixed on the FPC of LCM, featured by light and thin structure, low cost and easy production.
- 50 pins, including IO, UART, CAN, AD and PWM from user CPU core for easy secondary development.



DMG48270F043_02WTC

DMG48270F043_02WTCZ01

DMG48270F043_02WTCZ02

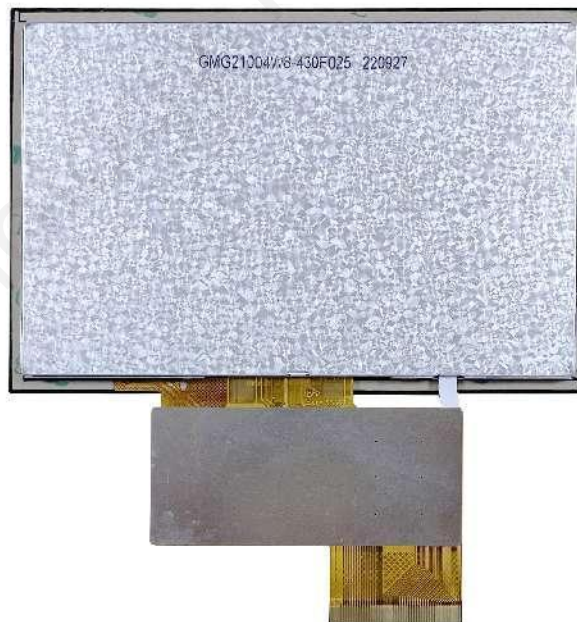

1 External Interface

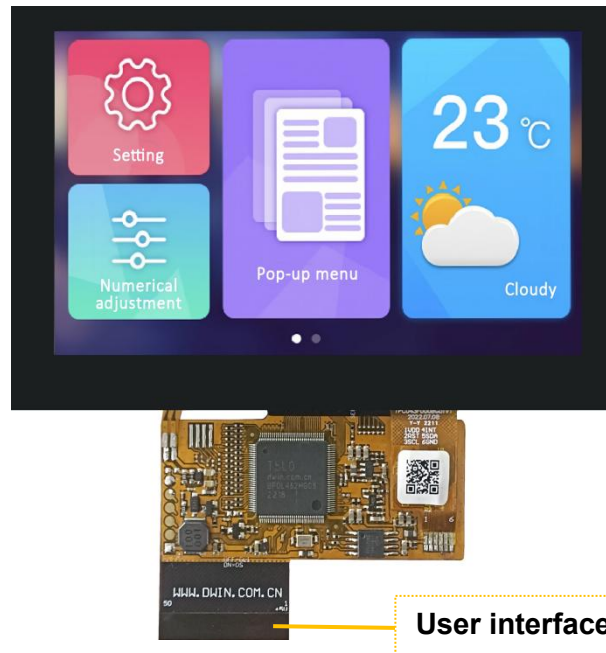

| PIN | Definition | I/O | Functional Description |
|-----|------------|-----|---|
| 1 | +5V | I | Power supply, DC3.6-5.5V. |
| 2 | +5V | I | |
| 3 | GND | GND | GND |
| 4 | GND | GND | |
| 5 | GND | GND | |
| 6 | AD7 | I | 5 input ADCs. 12-bit resolution in case of 3.3V power supply. 0-3.3V input voltage. Except for AD6, the rest data is sent to OS core via UART3 in real time with 16KHz sampling rate. AD1 and AD5 can be used in parallel, and AD3 and AD7 can be used in parallel, which equals to two 32KHz sampling AD. AD1, AD3, AD5, AD7 can be used in parallel, which equals to a 64KHz sampling AD; the data is summed 1024 times and then divided by 64 to obtain a 64Hz 16bit AD value by oversampling. |
| 7 | AD6 | I | |
| 8 | AD5 | I | |
| 9 | AD3 | I | |
| 10 | AD1 | I | |
| 11 | +3.3 | O | 3.3V output, maximum load of 150mA. |
| 12 | SPK | O | External MOSFET to drive buzzer or speaker. The external 10K resistor should be pulled down to the ground to ensure that power-on is low level. |
| 13 | SD_CD | IO | SD/SDHC interface, The SD_CD connects a 22pF capacitor to GND near the SD card interface. |
| 14 | SD_CK | O | |
| 15 | SD_D3 | IO | |
| 16 | SD_D2 | IO | |
| 17 | SD_D1 | IO | |
| 18 | SD_D0 | IO | |
| 19 | PWM0 | O | 2 16-bit PWM output. The external 10K resistor should be pulled down to the ground to ensure that power-on is low level. |
| 20 | PWM1 | O | The OS core can be controlled in real time via UART3. |
| 21 | P3.3 | IO | If using RX8130 or SD2058 I2C RTC to connect to both IOs, SCL should be connected to P3.2, and SDA connected to P3.3 in parallel with 10K resistor pull-up to 3.3V. |
| 22 | P3.2 | IO | |

| | | | |
|----|-----------|----|---|
| 23 | P3.1/EX1 | IO | It can be used as an external interrupt 1 input at the same time, and supports both low voltage level or trailing edge interrupt modes. |
| 24 | P3.0/EX0 | IO | It can be used as an external interrupt 0 input at the same time, and supports both low voltage level or trailing edge interrupt modes. |
| 25 | P2.7 | IO | IO interface |
| 26 | P2.6 | IO | IO interface |
| 27 | P2.5 | IO | IO interface |
| 28 | P2.4 | IO | IO interface |
| 29 | P2.3 | IO | IO interface |
| 30 | P2.2 | IO | IO interface |
| 31 | P2.1 | IO | IO interface |
| 32 | P2.0 | IO | IO interface |
| 33 | P1.7 | IO | IO interface |
| 34 | P1.6 | IO | IO interface |
| 35 | P1.5 | IO | IO interface |
| 36 | P1.4 | IO | IO interface |
| 37 | P1.3 | IO | IO interface |
| 38 | P1.2 | IO | IO interface |
| 39 | P1.1 | IO | IO interface |
| 40 | P1.0 | IO | IO interface |
| 41 | UART4_TXD | O | UART4 |
| 42 | UART4_RXD | I | |
| 43 | UART5_TXD | O | UART5 |
| 44 | UART5_RXD | I | |
| 45 | P0.0 | IO | IO interface |
| 46 | P0.1 | IO | IO interface |
| 47 | CAN_TX | O | CAN interface (External CAN chip drive is required. See 6 - (6) for circuit reference) |
| 48 | CAN_RX | I | |
| 49 | UART2_TXD | O | UART2(UART0 serial port of OS core) |
| 50 | UART2_RXD | I | |

2 Specification Parameters

2.1 Product Parameters

| | |
|-------------------------------|---|
| Main Chip | T5L0 |
| User Interface | 50Pin_0.5mm FPC |
| FLASH | 8M Bytes |
| UI Version | DGUSII / TA |
| Power Supply | HDL662S adapter board power supply |
| Display Color | 262K colors |
| Dimensions | 4.3 inch |
| Resolution | 480*272 |
| Active Area | 95.04mm (W)×53.86mm (H) |
| Viewing Angle | Wide viewing angle, typical value of 85° /85° /85° /85° (L/R/U/D) |
| Backlight Service Life | >10000 hours (Time of the brightness decaying to 50% on the condition of continuous working with the maximum brightness) |
| Brightness | DMG48270F043_02WTC:250nit DMG48270F043_02WTCZ01:250nit DMG48270F043_02WTCZ02:50nit |
| Brightness Control | 0~100 grade (When the brightness is adjusted to 1%~30% of the maximum brightness, flickering may occur and is not recommended to use in this range) |
| | |
| TP Type | CTP (Capacitive Touch Panel) |
| TP Structure | G+G structure |
| Touch Mode | Single point touch, support continuous sliding touch |
| Surface Hardness | 6H |
| Light Transmittance | Over 90% |
| Life | Over 1,000,000 times touch |

2.2 Interface Parameters

| Item | Conditions | Min | Typ | Max | Unit |
|---------------------|---|------|--------|---------|------|
| Baud Rate | User Set(Configure the CFG file) | 3150 | 115200 | 3225600 | bps |
| Output Voltage(TXD) | Output 1 | 3.0 | 3.3 | - | V |
| | Output 0 | - | 0 | 0.3 | V |
| Input Voltage(RXD) | Input 1 | - | - | 3.3 | V |
| | Input 0 | 0 | - | 0.5 | V |
| Interface | UART2: TTL; UART4: TTL; (Only available after OS configuration) UART5: TTL; (Only available after OS configuration) | | | | |
| Data Format | UART2: N81; UART4: N81/E81/O81/N82;4 modes (OS configuration) UART5: N81/E81/O81/N82;4 modes (OS configuration) | | | | |

2.3 Electrical specifications

| | | |
|--------------------------------------|-------------------------------|-----------------------|
| Rated Power | <5W | |
| Operating Voltage | 3.6~5.5V, typical value of 5V | |
| Operating Current | 220mA | VCC=5V, max backlight |
| | 100mA | VCC=5V, backlight off |
| Recommended power supply: 5V 0.5A DC | | |

2.4 Operating Environment

| | |
|-----------------------|------------------------------------|
| Operating Temperature | -10°C~60°C |
| Storage Temperature | -20°C~70°C |
| Operating Humidity | 10%~90%RH, typical value of 60% RH |

3 Reliability Test

3.1 ESD Test

Test temperature: 25°C

■ Test standard : EN 61000-4-2:2009 IEC 61000-4-2:2008 GB/T 17626.2-2018
 Other:

Table 1: Electrostatic Discharge Immunity (Air Discharge)

| Test Points Locations | Test Levels | | | | | | | |
|-----------------------|-------------|------|------|------|------|------|-------|-------|
| | -2kV | +2kV | -4kV | +4kV | -8kV | +8kV | -15kV | +15kV |
| Screen | / | / | / | / | A | A | / | / |
| / | / | / | / | / | / | / | / | / |
| / | / | / | / | / | / | / | / | / |

Table 2: Electrostatic Discharge Immunity (Direct Contact)

| Test Points Locations | Test Levels | | | | | | | |
|-----------------------|-------------|------|------|------|------|------|------|------|
| | -2kV | +2kV | -4kV | +4kV | -6kV | +6kV | -8kV | +8kV |
| / | / | / | / | / | / | / | / | / |
| / | / | / | / | / | / | / | / | / |
| / | / | / | / | / | / | / | / | / |

3.2 RE test

| Test Item | Test Standard | Result |
|-----------|---------------|------------------|
| RE | Class B | Normal operation |

HORIZONTAL

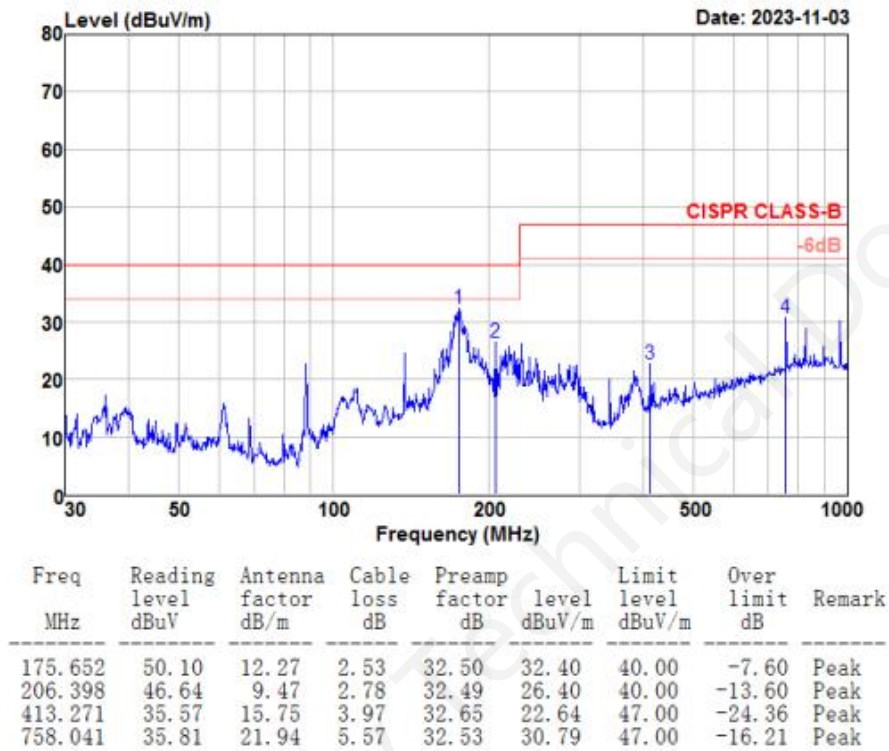

VERTICAL



3.3 High and Low Temperature Test

Test temperature:-20~70℃

Test process: the product will be placed obliquely in the high and low temperature test chamber for 12h for 20 on and off cycles. Then it will be check at room temperature after power on for the appearance and function, CTP offset situation, jumping point, page random switching and failure.

| Temperature | Result |
|------------------------|------------------|
| High temperature (70℃) | Normal operation |
| Low temperature (-20℃) | Normal operation |

4 Debug

It is recommended for new users of DWIN smart LCMs to purchase official accessories. For more details, please refer to customer service center.

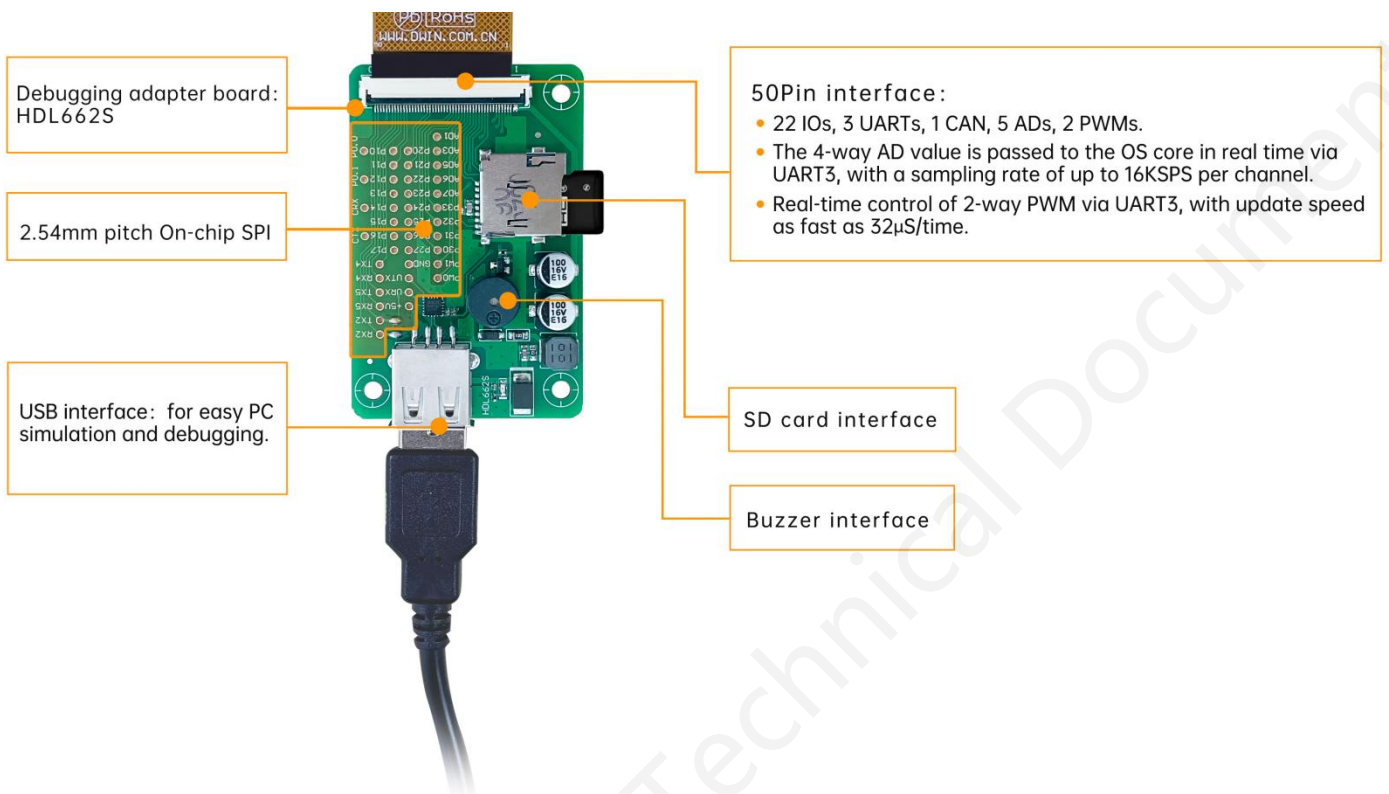

Operation steps: open serial assistant - custom function command - set command - send.

For example:

(1) Page switching

Tx: 5AA5 07 82 0084 5A01 0008

(2) Standby backlight setting

Tx: 5AA5 07 82 0082 64 32 03E8

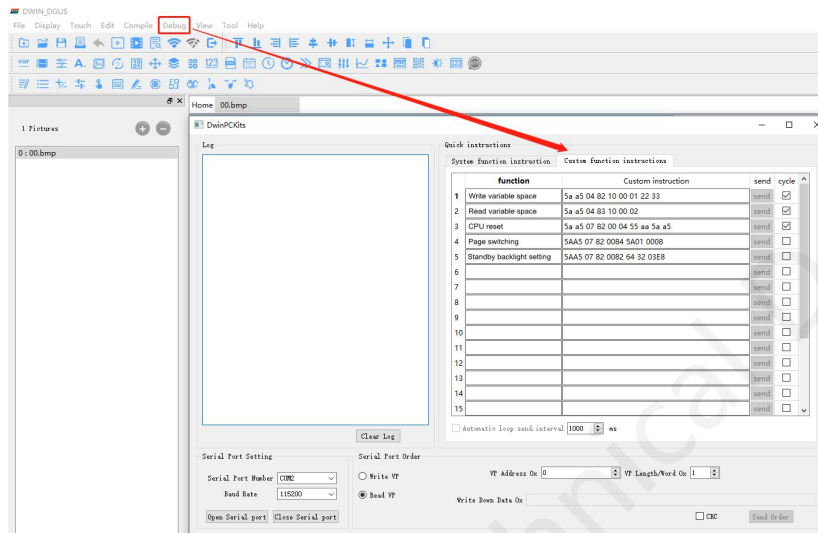

DGUS operation

5 T5L0 ASIC

T5L0 ASIC is a low-power, cost-effective, GUI and application highly integrated single-chip dual-core ASIC designed by DWIN Technology for small-size LCD and mass produced in 2020.

(1) Mature and stable 8051 core which is the most widely used with the maximum operating frequency of T5L is up to 250MHz, 1T(single instruction cycle)high speed operation.

(2) Separate GUI CPU core running DGUS II System:

- High-speed display memory, 2.4GB/S bandwidth. 18-bit color display resolution support up to 1024*768 (TA mode), 854*480 (DGUS mode).
- 2D hardware acceleration and the UI with animation and icons as its main feature is extremely cool and smooth.
- Images and icons stored in JPEG format. Adopt Low-cost 16Mbytes SPI Flash.
- High quality ratio and sound restoration and playback.
- 128Kbytes variable storage space for exchanging data with OS CPU Core and memory.
- 2 10-bit 800KHz DC/DC controllers simplify LED backlight, analog power design and save cost and space.
- Support DGUS development and simulation on PC. Support backend remote upgrade.

(3) Separate CPU (OS CPU) core runs user 8051 code or DWIN OS system and user CPU is omitted in practical application:

- Standard 8051 core and instruction set, 64Kbytes code space, 32Kbytes on-chip RAM.
- 64-bit integer mathematical operation unit (MDU), including 64-bit MAC and 64-bit divider.
- Built-in software WDT, 3 16-bit Timers, 12 interrupt signals support up to four levels of interrupt nesting.
- Support IAP online simulation and debugging with unlimited breakpoints.
- Upgrade code online through DGUS system.

(4) 1Mbytes on-chip Flash with DWIN patent encryption technology ensure code and data security.

(5) Operating temperature ranges from -40°C to +85°C(IC operating temperature customizable from -55°C to 105°C).

(6) Low power consumption and strong anti-interference ability. It can work stably on double-sided PCB and passes EMC/EMI test easily.

6 COF Screen Secondary Development

Standard 8051 core, easy to develop in C language and assembly language.

(1) 22 IOs:

To use output function of IO, you need to open the output control, output strength and peripheral multiplexing power-on initialization configuration. Subsequent use of IO is consistent with the standard 8051 as follows.

```
#include "sys.h"
sbit LED1 = P1^0;
sbit KEY1 = P1^1;
//Pin initialization
void io_init()
{
    PORTDRV = 0x01;//Driving current is 8mA
    P1MDOUT |= 0x01;//Set P1.0 as output to drive LED1 light
    P1MDOUT &= 0xFD;//Set P1.1 as input to read the voltage level change of the pin
}
void main(void)
{
    u16 cnt_1ms;
    u16 key1_sta;//Store the voltage level state of the KEY1 pin
    sys_init();//System initialization
    io_init();//Pin initialization
    cnt_1ms = 0;
    key1_sta = KEY1;
    while(1)
    {
        cnt_1ms++;
        sys_delay_ms(1);// Delay sub-function, LED1 blinks every 500ms.
        if(cnt_1ms==500)
        {
            LED1 = !LED1;
            cnt_1ms = 0;
        }
        //If the voltage level of the pin has changed, it will be updated in the interface
        if(key1_sta!=KEY1)
        {
            key1_sta = KEY1;
            sys_write_vp(0x1000,(u8*)&key1_sta,1);
        }
    }
}
```

(2) 3 UARTs:

High-speed serial port, supporting up to 3225600bps,as follows.

```
#include "sys.h"
#include "uart2.h"
void main(void)
{
    u16 len;
    sys_init();//System initialization
    uart2_init(115200);//Initialize serial port 2
    while(1)
    {
        if(uart2_rx_sta&UART2_PACKET_OK)//Received serial packet
        {
            len = uart2_rx_sta&UART2_PACKET_LEN;//Get the length of the serial packet without "\r\n"or '\n' terminator
            uart2_buf[len++] = 0;//Add 2 empty strings at the end
            uart2_buf[len++] = 0;
            printf("T5L_C51:%s\r\n",uart2_buf);//Return the received packet to the sender with the prefix "T5L_C51:"
            sys_write_vp(0x2000,uart2_buf,len/2+1);//At the same time display the packet to the interface
            uart2_rx_sta = 0;//Reset means that this serial packet is disposed of
        }
    }
}
```

(3) 1 CAN:

Only the special function registers of the CAN need to be configured as follows.

```

void CanInit()
{
    P0MDOUT = 0x04;    //P0.2(CAN_TX) is configured as output
    P0 = 0xFF;        //Output high voltage level
    ADR_H = 0xFF;     //Configuring DGUS variable memory addresses
    ADR_M = 0x00;
    ADR_L = 0x60;
    ADR_INC = 1;     //Configure address increments
    RAMMODE = 0x8F;  //Write mode
    while(!APP_ACK); //Waiting for confirmation,Among answers of Hardware to 8051 occupied variable memory request,
    1=OK and 0=BUSY, which need to continue to wait.
    DATA3 = 0x1A;   //Variable memory address 0xFF:0060 assignment
    DATA2 = 0x17;
    DATA1 = 0x0F;
    DATA0 = 0;
    APP_EN = 1;
    while(APP_EN);  //Wait for the data operation to be completed, and reset after the operation is completed
    DATA3 = 0;     //Acceptance register 0xFF:0061 assignment reset
    DATA2 = 0;
    DATA1 = 0;
    DATA0 = 0;
    APP_EN = 1;
    while(APP_EN);  //Wait for the data operation to be completed, and reset after the operation is completed
    DATA3 = 0xFF;  //Acceptance Mask Register 0xFF:0062 all set to 1, and no acceptance of reception
    DATA2 = 0xFF;
    DATA1 = 0xFF;
    DATA0 = 0xFF;
    APP_EN = 1;
    while(APP_EN);  //Wait for the data operation to be completed, and reset after the operation is completed
    RAMMODE = 0;    //Terminate access to DGUS variable memory
    CAN_CR = 0xA0;  //Open CAN and configure FF0060-FF0062
    while(CAN_CR&0x20); //Execute the configuration of FF0060-FF0062
    ECAN = 1;      //Open the CAN interrupt
    EA = 1;        //Open the total interrupt
}
    
```

(4) 5 A/Ds: 12-bit, supports sampling to 16-bit

Only the special function registers of the A/Ds need to be configured as follows.

```

#include "sys.h"
#include "adc.h"
void main(void)
{
    u16 ad;
    float vol;
    sys_init();//System initialization
    while(1)
    {
        ad = adc_read_avg(ADC_CHANNEL0,10);//1.Read the ad value of channel 0
        vol = ad*(3300.0f/4095);//2.Calculate the voltage in mV
        sys_write_vp(0x2000,(u8*)&ad,1);// Update the ad value
        sys_write_vp(0x2001,(u8*)&vol,2);//Update the voltage value
    }
}
    
```

(5) 2 PWMs: 16-bit high accuracy, adjustable resolution.

Only need to configure the frequency and duty cycle of PWM as follows.

```
void Pwm_0()
{
    u8 i=0;
    u8 temp[6]={0xAA,0x20,0x42,0x56,0x78,0}; //Set the pwm_0 duty cycle to 100%
    Write_Dgus(0x87,0x2042); //Configure the frequency 100khz
    Write_Dgus(0x86,0x5A01); //
    for(i=0;i<5;i++) //Checksum
        temp[5]+=temp[i];
    for(i=0;i<6;i++) //Configure the duty cycle
        OneSendData3(temp[i]);
}
```

(6) CAN circuit design parameters

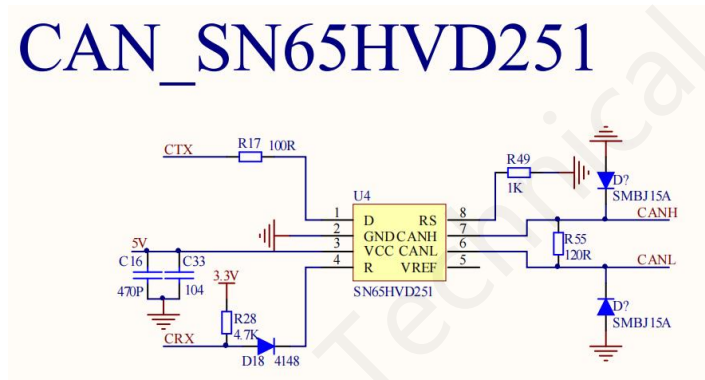

7 Packing Capacity & Dimension

| Dimension | | | | |
|-------------------|--|-------|----------------|---------------|
| Dimension | DMG48270F043_02WTC: 111.50(W) ×74.10 (H) ×4.77(T) mm DMG48270F043_02WTCZ01: 111.50(W) ×74.10 (H) ×4.77(T) mm DMG48270F043_02WTCZ02: 111.50(W) ×74.10 (H) ×5.42(T) mm | | | |
| Net Weight | DMG48270F043_02WTC: 75g DMG48270F043_02WTCZ01: 75g DMG48270F043_02WTCZ02: 85g | | | |
| Packing Capacity | | | | |
| Model | Size | Layer | Quantity/Layer | Quantity(Pcs) |
| Carton1: | 220mm(L)×160mm(W)×47mm(H) | 1 | 4 | 4 |
| Carton2: | 250mm(L)×200mm(W)×80mm(H) | 1 | 8 | 8 |
| Carton3: | 320mm(L)×270mm(W)×80mm(H) | 1 | 16 | 16 |
| Carton4: | 415mm(L)×250mm(W)×200mm(H) | - | - | 102 |

Disclaimer: The product design is subject to alternation and improvement without prior notice.

G+G China glass, black cover plate

LCD PIN Definition

| PIN# | Name | 26 | P26 |
|------|-------|----|-----|
| 1 | +5V | 27 | P25 |
| 2 | +5V | 28 | P24 |
| 3 | GND | 29 | P23 |
| 4 | GND | 30 | P22 |
| 5 | GND | 31 | P21 |
| 6 | ADC7 | 32 | P20 |
| 7 | ADC6 | 33 | P17 |
| 8 | ADC5 | 34 | P16 |
| 9 | ADC3 | 35 | P15 |
| 10 | ADC1 | 36 | P14 |
| 11 | +3.3V | 37 | P13 |
| 12 | SPK | 38 | P12 |
| 13 | SD_CD | 39 | P11 |
| 14 | SD_CK | 40 | P10 |
| 15 | SDD3 | 41 | TX4 |
| 16 | SDD2 | 42 | TX4 |
| 17 | SDD1 | 43 | TX5 |
| 18 | SDD0 | 44 | RX5 |
| 19 | PWM0 | 45 | P00 |
| 20 | PWM1 | 46 | P01 |
| 21 | P33 | 47 | P02 |
| 22 | P32 | 48 | P03 |
| 23 | P31 | 49 | TX2 |
| 24 | P30 | 50 | RX2 |
| 25 | P27 | | |

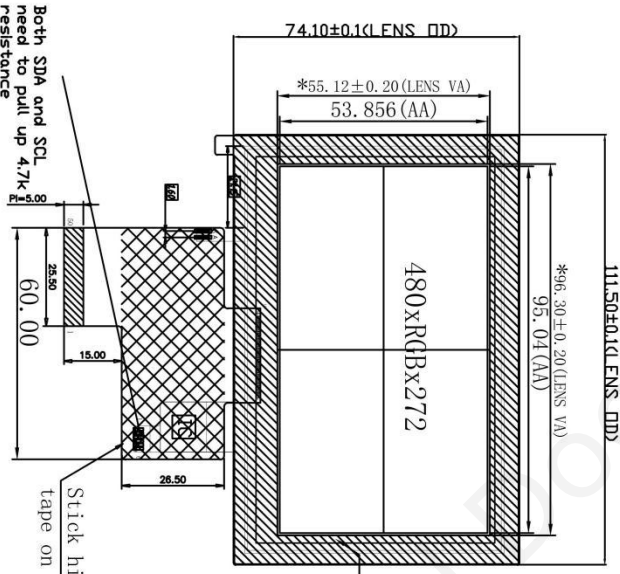

Front view

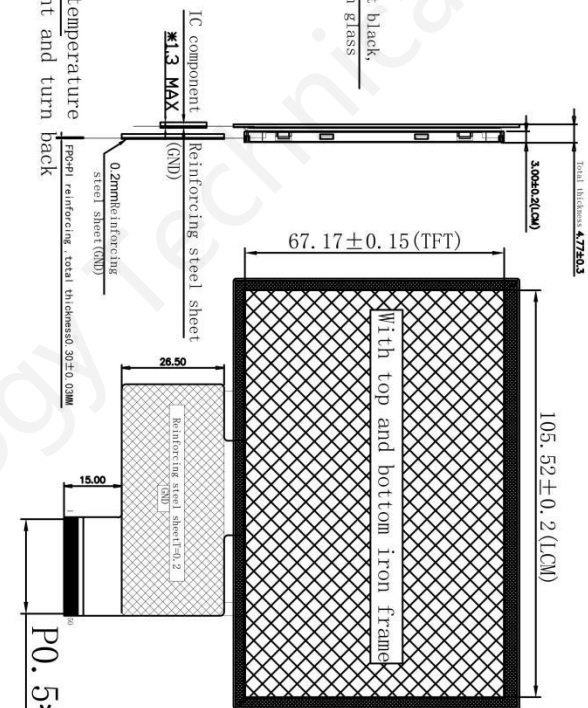

Side view

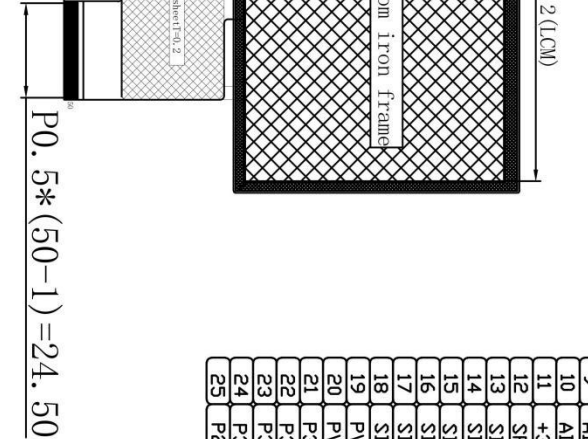

Back view

| PIN# | Name |
|------|----------|
| 1 | VDD-3.3V |
| 2 | RST |
| 3 | SCL |
| 4 | INT |
| 5 | SDA |
| 6 | GND |

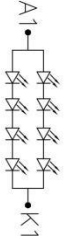

* Circuit Diagram (LED 8PCS) color: WHITE
VF=12V IF=40mA

| REVISION RECORD | VER | DATE | DWIN Technology | | |
|-----------------|---------------|-----------------|-----------------|--------------------|-------------------|
| 1 | First Edition | VF-1 (20220913) | FILE NAME : | DMG48270F043_02WTC | TOLERANCES : ±0.2 |
| 2 | | | CUSTOMER NAME : | | ANGLES : ±0.1° |
| 3 | | | DESIGN : | | SCALE : 1:1 |
| 4 | | | DRAWN BY : | Kerry | DATE : 20220913 |
| 5 | | | CHECKED BY : | | DATE : |
| 6 | | | APPROVED BY : | | DATE : |

G+G China Glass , printing white

LCD PIN Definition

| PIN# | Name | 26 | P26 |
|------|-------|----|-----|
| 1 | +5V | 27 | P25 |
| 2 | +5V | 28 | P24 |
| 3 | GND | 29 | P23 |
| 4 | GND | 30 | P22 |
| 5 | GND | 31 | P21 |
| 6 | ADC7 | 32 | P20 |
| 7 | ADC6 | 33 | P17 |
| 8 | ADC5 | 34 | P16 |
| 9 | ADC3 | 35 | P15 |
| 10 | ADC1 | 36 | P14 |
| 11 | +3.3V | 37 | P13 |
| 12 | SPK | 38 | P12 |
| 13 | SD_CD | 39 | P11 |
| 14 | SD_CK | 40 | P10 |
| 15 | SD_D3 | 41 | TX4 |
| 16 | SDD2 | 42 | RX4 |
| 17 | SDD1 | 43 | TX5 |
| 18 | SDD0 | 44 | RX5 |
| 19 | PWM0 | 45 | P00 |
| 20 | PVMI | 46 | P01 |
| 21 | P33 | 47 | P02 |
| 22 | P32 | 48 | P03 |
| 23 | P31 | 49 | TX2 |
| 24 | P30 | 50 | RX2 |
| 25 | P27 | | |

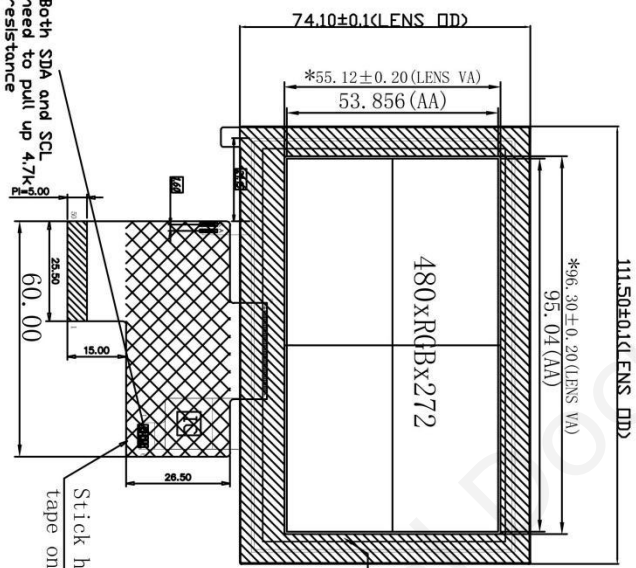

Front view

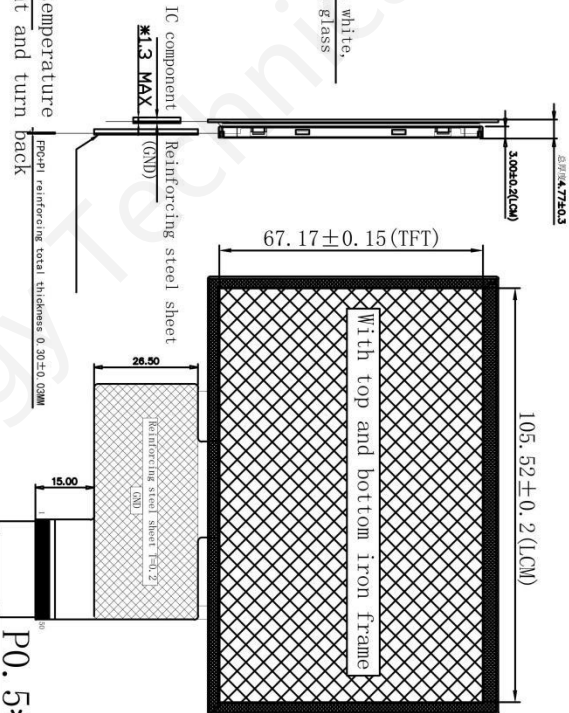

Side view



Back view

| PIN# | Name |
|------|----------|
| 1 | VDD-3.3V |
| 2 | RST |
| 3 | SCL |
| 4 | INT |
| 5 | SDA |
| 6 | GND |

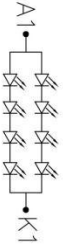

* Circuit Diagram
(LED 8PCS) Color: WHITE
VF=12V IF=40mA

| REVISION RECORD | VER | DATE | DWIN Technology | | |
|-----------------|---------------|------|-----------------|-----------------|----------------------|
| 1 | First Edition | V1-1 | 20220913 | FILE NAME : | DMG48270F043_02WTC01 |
| 2 | | | | CUSTOMER NAME : | |
| 3 | | | | DESIGN : | |
| 4 | | | | DRAWN BY : | Kerry |
| 5 | | | | DATE | 20220913 |
| 6 | | | | CHECKED BY : | |
| | | | | APPROVED BY : | |

G+G Domestic glass, integrated black cover

LCD PIN Definition

| PIN# | Name | 26 | P26 |
|------|-------|----|-----|
| 1 | +5V | 27 | P25 |
| 2 | +5V | 28 | P24 |
| 3 | GND | 29 | P23 |
| 4 | GND | 30 | P22 |
| 5 | GND | 31 | P21 |
| 6 | ADC7 | 32 | P20 |
| 7 | ADC6 | 33 | P17 |
| 8 | ADC5 | 34 | P16 |
| 9 | ADC3 | 35 | P15 |
| 10 | ADC1 | 36 | P14 |
| 11 | +3.3V | 37 | P13 |
| 12 | SPK | 38 | P12 |
| 13 | SD_CD | 39 | P11 |
| 14 | SD_CK | 40 | P10 |
| 15 | SDD3 | 41 | TX4 |
| 16 | SDD2 | 42 | RX4 |
| 17 | SDD1 | 43 | TX5 |
| 18 | SDD0 | 44 | RX5 |
| 19 | PWM0 | 45 | P00 |
| 20 | PWM1 | 46 | P01 |
| 21 | P33 | 47 | P02 |
| 22 | P32 | 48 | P03 |
| 23 | P31 | 49 | TX2 |
| 24 | P30 | 50 | RX2 |
| 25 | P27 | | |

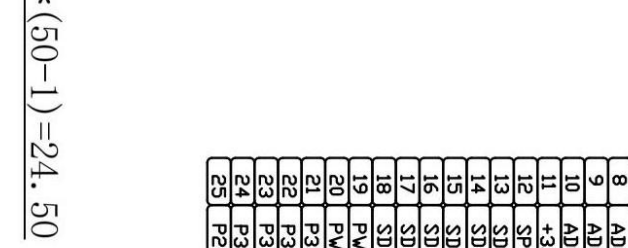
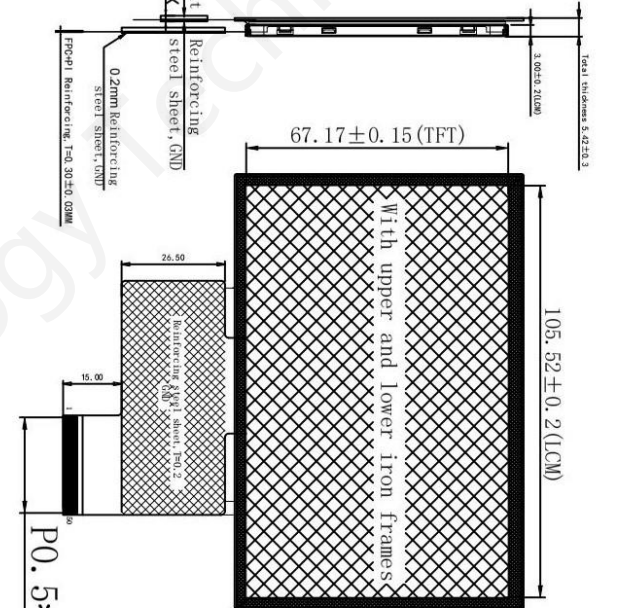
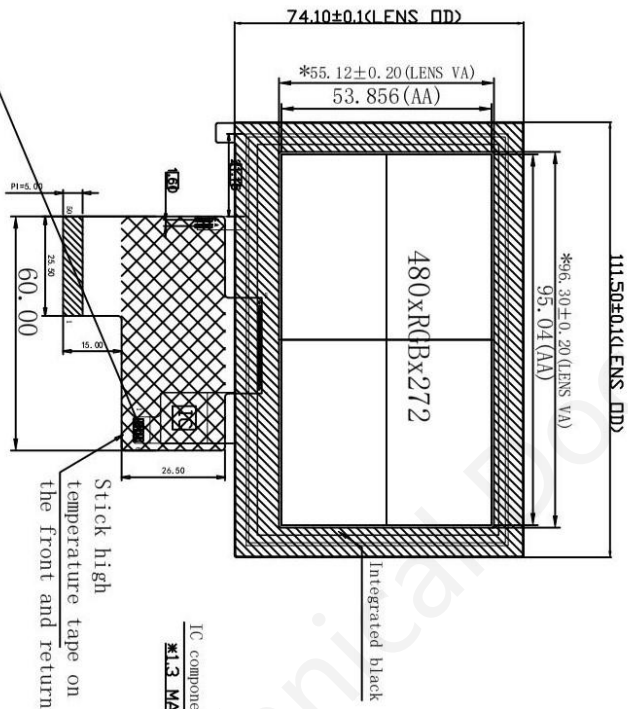

Front view

Side view

Back view

| PIN# | Name |
|------|----------|
| 1 | VDD-3.3V |
| 2 | RST |
| 3 | SCL |
| 4 | INT |
| 5 | SDA |
| 6 | GND |

Both SDA and SCL need to pull up 4.7k resistors
Pin Definition

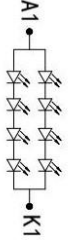

* Circuit Diagram
(LED RPCS) Color: WHITE
Vf=12V If=10mA

| REVISION RECORD | | | DWIN Technology | | |
|-----------------|---------------|------|-----------------|--------------------|-------|
| REV | DATE | VER | FILE NAME | DESIGNER | SCALE |
| 1 | First Edition | VI-1 | 20220913 | DMG48270F043_02WTC | ±0.2 |
| 2 | | | | | |
| 3 | | | | | |
| 4 | | | | | |
| 5 | | | | | |
| 6 | | | | | |

8 Revision records

| Rev | Revise Date | Content | Editor |
|-----|-------------|---------------|---------|
| 00 | 2023-12-20 | First Edition | Xu Ying |

Please contact us if you have any questions about the use of this document or our products, or if you would like to know the latest information about our products:

- Customer service Tel: +86 400 018 9008
- Customer service email: dwinhmi@dwin.com.cn
- DWIN Developer Forum: <https://forums.dwin-global.com/>

Thank you all for continuous support of DWIN, and your approval is the driving force of our progress!