

Power Relays ( Over 2 A )  
**LD-P RELAYS**

Product Catalog

**IN Your  
Future**

# LD-P RELAYS

## Compliant with IEC/EN60335-1/ EN60079-15 (VDE approved)<sup>1</sup> Form A 5A slim power relays

Protective construction : Sealed

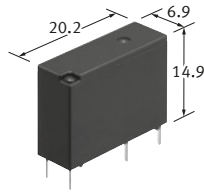

(Unit : mm)

### FEATURES

- **Rated switching capacity: 5 A 277 V AC**
- **Ambient temperature: -40 to +85°C**
- **Compact size: 6.9 mm (W) X 20.2mm (L) X 14.9mm (H)**
- **Compliant with IEC/EN60335-1<sup>\*1</sup> (VDE approved)**  
EN60695 (GWT2-11, GWFI2-12, GWIT2-1) data available  
<sup>\*1</sup>: Common safety standard for major electrical appliance
- **Compliant with IEC/EN60079-15<sup>\*2</sup> (VDE approved)**  
<sup>\*2</sup>: Explosion-proof certification

### TYPICAL APPLICATIONS

- **Boilers, Hot water units**
- **Air conditioner, Fan heaters**
- **Refrigerator**
- **Microwave ovens**

### ORDERING INFORMATION (PART NO.)

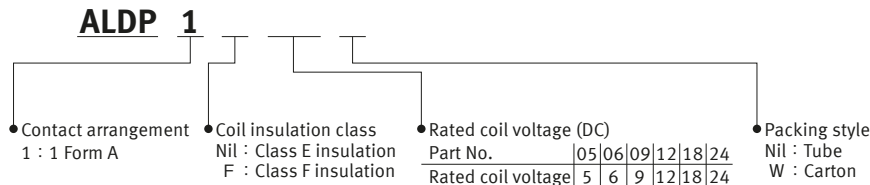

Note) The "W" at the end of the part number only appears on the inner and outer packing.  
It does not appear on the relay itself.

### TYPES

Contact arrangement	Rated coil voltage	Part No. *		Standard packing	
		Class E insulation	Class F insulation	Inner carton	Outer carton
1 Form A	5 V DC	ALDP105W	ALDP1F05W	Carton: 100 pcs Tube: 50 pcs	Carton: 500 pcs Tube: 1,000 pcs
	6 V DC	ALDP106W	ALDP1F06W		
	9 V DC	ALDP109W	ALDP1F09W		
	12 V DC	ALDP112W	ALDP1F12W		
	18 V DC	ALDP118W	ALDP1F18W		
	24 V DC	ALDP124W	ALDP1F24W		

\* Tube packing types available. When ordering, please remove suffix "W".

# Power Relays (Over 2 A) LD-P RELAYS

## RATING

### Coil data

- Operating characteristics such as 'Operate voltage' and 'Release voltage' are influenced by mounting conditions, ambient temperature, etc.

Therefore, please use the relay within  $\pm 5\%$  of rated coil voltage.

- 'Initial' means the condition of products at the time of delivery.

Rated coil voltage	Operate voltage*1 (at 20°C)	Release voltage*1 (at 20°C)	Rated operating current ( $\pm 10\%$ , at 20°C)	Coil resistance ( $\pm 10\%$ , at 20°C)	Rated operating power	Max. allowable voltage*2 (at 20°C)
5 V DC	Max. 75% V of rated coil voltage (Initial)	Min. 5% V of rated coil voltage (Initial)	40 mA	125 $\Omega$	200 mW	180% V of rated coil voltage
6 V DC			33.3 mA	180 $\Omega$		
9 V DC			22.2 mA	405 $\Omega$		
12 V DC			16.7 mA	720 $\Omega$		
18 V DC			11.1 mA	1,620 $\Omega$		
24 V DC			8.3 mA	2,880 $\Omega$		

\*1. square, pulse drive

\*2. Maximum allowable voltage is the maximum voltage which can satisfy the coil temperature rise value. Please refer to "Max. applied voltage and temperature rise" in GUIDELINES FOR USAGE.

### Specifications

Item	Specifications	
Contact data	Contact arrangement	1 Form A
	Contact resistance (initial)	Max. 100 m $\Omega$ (by voltage drop 6 V DC 1 A)
	Contact material	AgNi type
	Contact rating (resistive)	5 A 277 V AC, 3 A 30 V DC
	Max. switching power (resistive)	1,385 VA, 90 W
	Max. switching voltage	277 V AC, 30 V DC
	Max. switching current	5 A (AC), 3 A (DC)
	Min. switching load (reference value)*1	100 mA 5 V DC
Insulation resistance (initial)	Min. 1,000 M $\Omega$ (at 500 V DC, Measured portion is the same as the case of dielectric strength.)	
Dielectric strength (initial)	Between open contacts	750 Vrms for 1 min (detection current: 10 mA)
	Between contact and coil	4,000 Vrms for 1 min (detection current: 10 mA)
Surge withstand voltage (initial)*2	Between contact and coil	10,000 V
Time characteristics (initial)	Operate time	Max. 10 ms at rated coil voltage (at 20°C, without bounce)
	Release time	Max. 10 ms at rated coil voltage (at 20°C, without bounce, with diode)
Shock resistance	Functional	300 m/s <sup>2</sup> (half-sine shock pulse: 11 ms, detection time: 10 $\mu$ s)
	Destructive	1,000 m/s <sup>2</sup> (half-sine shock pulse: 6 ms)
Vibration resistance	Functional	10 to 55 Hz (at double amplitude of 1.5 mm, detection time: 10 $\mu$ s)
	Destructive	10 to 55 Hz (at double amplitude of: 1.5 mm)
Expected life	Mechanical life	Min. $5 \times 10^6$ ope. (at 180 times/min)
Conditions	Conditions for usage, transport and storage*3	Ambient temperature: -40 to +85°C, Humidity: 5 to 85% RH (Avoid icing and condensation)
Unit weight		Approx. 4 g

\*1. This value can change due to the switching frequency, environmental conditions, and desired reliability level, therefore it is recommended to check this with the actual load.

\*2. Wave is standard shock voltage of  $\pm 1.2 \times 50 \mu$ s according to JEC-212-1981

\*3. For ambient temperature, please read "GUIDELINES FOR RELAY USAGE".

### Expected electrical life

Conditions: Resistive load, at 20°C, switching frequency at 20 times/min

Type	Switching capacity	Number of operations
1 Form A	5 A 125 V AC	Min. $200 \times 10^3$ ope.
	5 A 250 V AC	Min. $100 \times 10^3$ ope.
	3 A 30 V DC	Min. $100 \times 10^3$ ope.

# Power Relays (Over 2 A) LD-P RELAYS

## REFERENCE DATA

### 1. Max. switching capacity

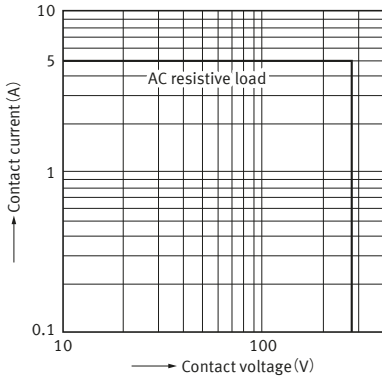

### 2. Coil temperature characteristics (Average)

Tested sample : ALDP112, 6 pcs.  
 Measured portion : Coil inside  
 Contact current : 0A, 5A

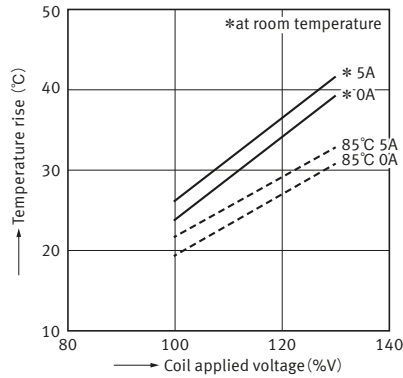

### 3-1. Operate time

Tested sample : ALDP112, 30 pcs.

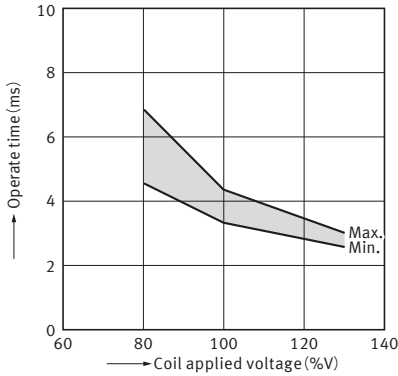

### 3-2. Release time (without diode)

Tested sample : ALDP112, 30 pcs.

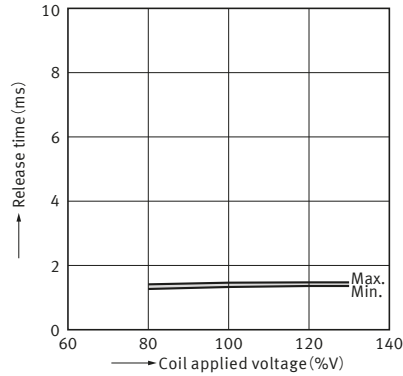

### 3-3. Release time (with diode)

Tested sample : ALDP112, 30 pcs.

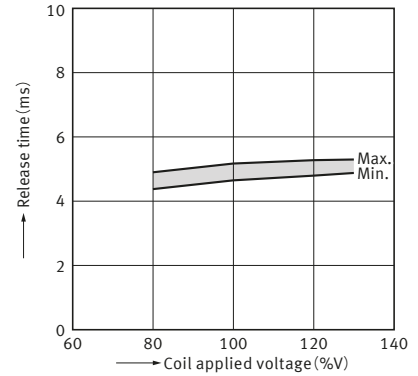

### 4. Electrical life test (5A 250 V AC Resistive load)

Tested sample : ALDP112, 6 pcs.  
 Operation frequency : 20 times/min.  
 (ON : OFF=1.5s : 1.5s)  
 Ambient temperature : 20°C  
 Circuit :

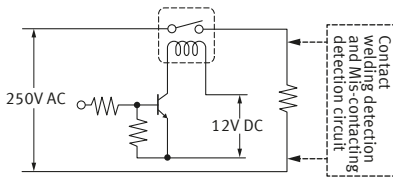

#### Change of operate and release voltage

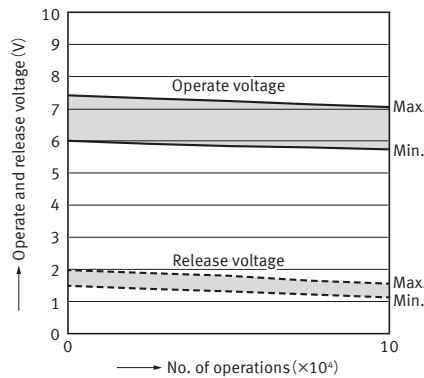

#### Change of contact resistance

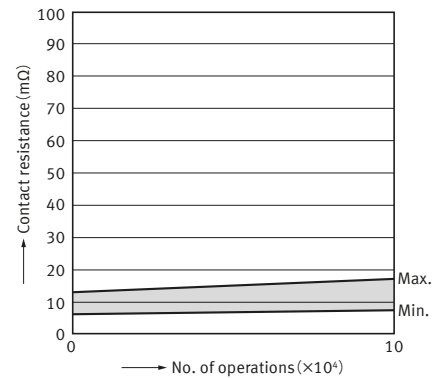

# Power Relays (Over 2 A) LD-P RELAYS

## DIMENSIONS

**CAD** The CAD data of the products with a "CAD" mark can be downloaded from our Website.

Unit: mm

### CAD



### External dimensions

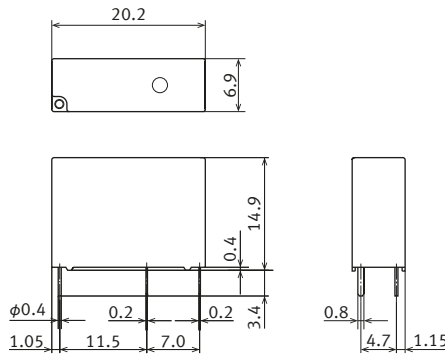

General tolerance  
 Less than 1 mm : ±0.1  
 Min. 1mm less than 3mm : ±0.2  
 Min. 3mm : ±0.3

### Recommended PC board pattern (BOTTOM VIEW)

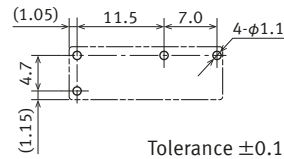

### Schematic (BOTTOM VIEW)

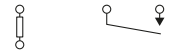

## SAFETY STANDARDS

Each standard may be updated at any time, so please check our Website for the latest information.

### UL/C-UL (Approved)

File No.	Contact rating	Operations	Ambient temperature
E43028	6 A 277 V AC General use	50 x 10 <sup>3</sup>	40 °C
	5 A 277 V AC Resistive	100 x 10 <sup>3</sup>	85 °C
	5 A 277 V AC General use	100 x 10 <sup>3</sup>	40 °C
	5 A 277 V AC General use	50 x 10 <sup>3</sup>	85 °C
	3 A 277 V AC General use	120 x 10 <sup>3</sup>	85 °C
	Pilot Duty C 300	100 x 10 <sup>3</sup>	85 °C
	Pilot Duty 0.65 A 277 V AC (Inrush 6.5 A)	100 x 10 <sup>3</sup>	85 °C
	5 A 30 V DC Resistive	100 x 10 <sup>3</sup>	40 °C
	5 A 30 V DC Resistive	10 x 10 <sup>3</sup>	85 °C
	5 A 277 V AC Resistive (class F only)	50 x 10 <sup>3</sup>	105 °C
	4 A 277 V AC Resistive (class F only)	100 x 10 <sup>3</sup>	105 °C
	1 FLA/6 LRA 277 V AC (class F only)	30 x 10 <sup>3</sup>	105 °C

\*Pilot Duty comply with UL508 conditions

### VDE (Approved)

File No.	Contact rating	Operations	Ambient temperature
40014384	5 A 250 V AC (cosφ = 1.0)	100 x 10 <sup>3</sup>	85 °C
	3 A 400 V AC (cosφ = 1.0)	10 x 10 <sup>3</sup>	85 °C
	5 A 30 V DC (0 ms)	10 x 10 <sup>3</sup>	25 °C
	5 A 250 V AC (cosφ = 1.0) (class F only)	50 x 10 <sup>3</sup>	105 °C

### CSA (Approved)

CSA standard approved by C-UL

### CQC (Approved)

File No.	Contact rating	Ambient temperature
CQC10002048611	5 A 250 V AC	85 °C

Note: Excluding Class F insulation

## INSULATION CHARACTERISTICS (IEC61810-1)

Item	Characteristics	
Clearance/Creepage distance (IEC61810-1)	Min. 5.5 mm/5.5 mm	
Category of protection (IEC61810-1)	RT III	
Tracking resistance (IEC60112)	PTI 175	
Insulation material group	III a	
Over voltage category	III	
Rated voltage	250 V	
Pollution degree	3	2
Type of insulation (Between contact and coil)	Basic insulation	Reinforced insulation
Type of insulation (Between open contacts)	Micro disconnection	

Note: EN/IEC VDE Certified.

### GUIDELINES FOR USAGE

■ For cautions for use, please read “GUIDELINES FOR RELAY USAGE”.  
[https://industrial.panasonic.com/ac/e/control/relay/cautions\\_use/index.jsp](https://industrial.panasonic.com/ac/e/control/relay/cautions_use/index.jsp)

---

#### ■ Cautions for usage of LD-P relays

##### ● Max. applied voltage and temperature rise

Proper usage requires that the rated voltage be impressed on the coil. Note, however, that if a voltage greater than or equal to the maximum applied voltage is impressed on the coil, the coil may burn or its layers short due to the temperature rise. Furthermore, do not exceed the usable ambient temperature range listed in the catalog.

- For cautions for use, please read " GUIDELINES FOR RELAY USAGE ".  
[https://industrial.panasonic.com/ac/e/control/relay/cautions\\_use/index.jsp](https://industrial.panasonic.com/ac/e/control/relay/cautions_use/index.jsp)

## Precautions for Coil Input

### ■ Long term current carrying

A circuit that will be carrying a current continuously for long periods without relay switching operation. ( circuits for emergency lamps, alarm devices and error inspection that, for example, revert only during malfunction and output warnings with form B contacts ) Continuous, long-term current to the coil will facilitate deterioration of coil insulation and characteristics due to heating of the coil itself. For circuits such as these, please use a magnetic-hold type latching relay. If you need to use a single stable relay, use a sealed type relay that is not easily affected by ambient conditions and make a failsafe circuit design that considers the possibility of contact failure or disconnection.

### ■ DC Coil operating power

Steady state DC current should be applied to the coil. The wave form should be rectangular. If it includes ripple, the ripple factor should be less than 5 %. However, please check with the actual circuit since the electrical characteristics may vary. The rated coil voltage should be applied to the coil and the set/reset pulse time of latching type relay differs for each relays, please refer to the relay's individual specifications.

### ■ Coil connection

When connecting coils of polarized relays, please check coil polarity ( + , - ) at the internal connection diagram ( Schematic ). If any wrong connection is made, it may cause unexpected malfunction, like abnormal heat, fire and so on, and circuit do not work. Avoid impressing voltages to the set coil and reset coil at the same time.

### ■ Maximum allowable voltage and temperature rise

Proper usage requires that the rated coil voltage be impressed on the coil. Note, however, that if a voltage greater than or equal to the maximum continuous voltage is impressed on the coil, the coil may burn or its layers short due to the temperature rise. Furthermore, do not exceed the usable ambient temperature range listed in the catalog.

### ● Operate voltage change due to coil temperature rise

In DC relays, after continuous passage of current in the coil, if the current is turned OFF, then immediately turned ON again, due to the temperature rise in the coil, the operate voltage will become somewhat higher. Also, it will be the same as using it in a higher temperature atmosphere. The resistance/temperature relationship for copper wire is about 0.4 % for 1 °C, and with this ratio the coil resistance increases. That is, in order to operate of the relay, it is necessary that the voltage be higher than the operate voltage and the operate voltage rises in accordance with the increase in the resistance value. However, for some polarized relays, this rate of change is considerably smaller.

## Ambient Environment

### Usage, Transport, and Storage Conditions

During usage, storage, or transportation, avoid locations subjected to direct sunlight and maintain normal temperature, humidity and pressure conditions.

#### Temperature/Humidity/Pressure

When transporting or storing relays while they are tube packaged, there are cases the temperature may differ from the allowable range. In this case be sure to check the individual specifications.

Also allowable humidity level is influenced by temperature, please check charts shown below and use relays within mentioned conditions. ( Allowable temperature values differ for each relays, please refer to the relay's individual specifications. )

##### 1) Temperature:

The tolerance temperature range differs for each relays, please refer to the relay's individual specifications

##### 2) Humidity: 5 to 85 % RH

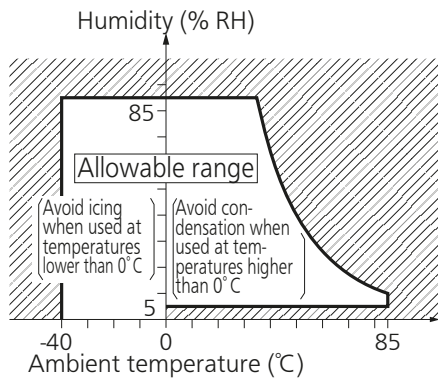

##### 3) Pressure: 86 to 106 kPa

#### Dew condensation

Condensation occurs when the ambient temperature drops suddenly from a high temperature and humidity, or the relay is suddenly transferred from a low ambient temperature to a high temperature and humidity.

Condensation causes the failures like insulation deterioration, wire disconnection and rust etc.

Panasonic Industry Co., Ltd. does not guarantee the failures caused by condensation.

The heat conduction by the equipment may accelerate the cooling of device itself, and the condensation may occur.

Please conduct product evaluations in the worst condition of the actual usage. ( Special attention should be paid when high temperature heating parts are close to the device. Also please consider the condensation may occur inside of the device. )

#### Icing

Condensation or other moisture may freeze on relays when the temperature become lower than 0 °C. This icing causes the sticking of movable portion, the operation delay and the contact conduction failure etc. Panasonic Industry Co., Ltd. does not guarantee the failures caused by the icing.

The heat conduction by the equipment may accelerate the cooling of relay itself and the icing may occur. Please conduct product evaluations in the worst condition of the actual usage.

#### Low temperature and low humidity

The plastic becomes brittle if the relay is exposed to a low temperature, low humidity environment for long periods of time.

#### High temperature and high humidity

Storage for extended periods of time ( including transportation periods ) at high temperature or high humidity levels or in atmospheres with organic gases or sulfide gases may cause a sulfide film or oxide film to form on the surfaces of the contacts and/or it may interfere with the functions. Check out the atmosphere in which the units are to be stored and transported.

#### Package

In terms of the packing format used, make every effort to keep the effects of moisture, organic gases and sulfide gases to the absolute minimum.

#### Silicon

When a source of silicone substances ( silicone rubber, silicone oil, silicone coating materials and silicone filling materials etc. ) is used around the relay, the silicone gas ( low molecular siloxane etc. ) may be produced.

This silicone gas may penetrate into the inside of the relay. When the relay is kept and used in this condition, silicone compound may adhere to the relay contacts which may cause the contact failure. Do not use any sources of silicone gas around the relay ( Including plastic sealed types ).

#### NOx Generation

When relay is used in an atmosphere high in humidity to switch a load which easily produces an arc, the NOx created by the arc and the water absorbed from outside the relay combine to produce nitric acid.

This corrodes the internal metal parts and adversely affects operation.

Avoid use at an ambient humidity of 85 % RH or higher ( at 20 °C ). If use at high humidity is unavoidable, please contact our sales representative.



## Others

### ■ Cleaning

- Although the environmentally sealed type relay ( plastic sealed type, etc. ) can be cleaned, avoid immersing the relay into cold liquid ( such as cleaning solvent ) immediately after soldering. Doing so may deteriorate the sealing performance.
- Cleaning with the boiling method is recommended ( The temperature of cleaning liquid should be 40 °C or lower ). Avoid ultrasonic cleaning on relays. Use of ultrasonic cleaning may cause breaks in the coil or slight sticking of the contacts due to ultrasonic energy.

Please refer to "**the latest product specifications**" when designing your product.

- Requests to customers:

<https://industrial.panasonic.com/ac/e/salespolicies/>

■ Global Sales Network Information: [industrial.panasonic.com/ac/e/salesnetwork](https://industrial.panasonic.com/ac/e/salesnetwork)

---

**Panasonic**  
INDUSTRY

**Panasonic Industry Co., Ltd.**

Electromechanical Control Business Division

■ 1006, Oaza Kadoma, Kadoma-shi, Osaka 571-8506, Japan  
[industrial.panasonic.com/ac/e/](https://industrial.panasonic.com/ac/e/)